



# DEFENSE PROFILE

2 0 2 5

59°03'54.6"N  
5°55'24.1"E

59.0652651042984 / 5.9236666840958598



**COMROD**  
Reaching further



# REACHING FURTHER

COMROD is a multinational group of companies with locations in Norway, France, Sweden, Hungary, and the USA.

Since 1948, COMROD has grown through a dedication to innovation in research, development, and manufacturing. This dedication has earned COMROD a global reputation for quality and performance.

## Antenna Overview

- Antenna Reduction & Optimization Systems
- Vehicle Antennas
- Manpack & Handheld Antennas
- Ground Deployed Antennas
- Shipboard Antennas

## Mast Overview

- Telescopic Aluminum Masts
- Telescopic Composite Masts
- Tripod Sectional Masts
- Man-Portable Composite Masts
- Mast Payload Alignment Systems

## Mission Planning Software Overview

- Tactical Communication Planning Software
- Deployment Scheduling
- Frequency Management
- RF Link Analysis

## Power Supply Overview

- Battery Chargers
- AC/DC Converters
- DC/DC Conditioners
- DC/AC Inverters
- Dual AC/DC & DC/DC Converters

## RF Signal Amplification

- Power Amplifiers
- Bi-Directional Amplifiers
- Integrated Amplified Radio Systems

## THPR High Power Integrated Radio Systems

- Amplified versions of existing radio systems
- SISO and MIMO
- L, S, & C Bands

## CubeSat & Satellite Systems

- Power Amplifiers
- Bi-Directional Amplifiers
- Frequency Translation Amplifiers
- Radio Frequency Extension Modules

## Turn-Key Datalink Systems

- Long-range / High-throughput datalinks



# ANTENNA OVERVIEW

Our customers demand reliable communications. We provide the performance and reliability they can trust. COMROD's field-proven antennas have earned a reputation in the industry for innovative engineering and unmatched quality.



**ANTENNA REDUCTION & OPTIMIZATION SYSTEMS**



**MANPACK ANTENNAS**

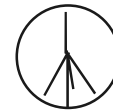

**GROUND DEPLOYED ANTENNAS**



**SUBMARINE ANTENNA SYSTEMS**



**VEHICLE ANTENNAS**



**HANDHELD ANTENNAS**



**SHIPBOARD ANTENNAS**



# ANTENNA REDUCTION & OPTIMIZATION SYSTEMS

Antenna reduction and optimization with limited platform or ground deployment space is a critical challenge in modern communication systems. Ground-to-ground, ground-to-air and jamming systems all demand optimal performance while minimizing the effects of co-site interference. Comrod has a range of sophisticated multiband antenna designs suited to the constraints of limited platform or ground deployment space. Combining these antennas with highly configurable antenna control systems (ACS), combiners, splitters and diplexers, ensures minimal visual signature and reduced cable harnessing, while optimizing overall system performance.

**System performance approach.** Decades of developing and manufacturing antennas for the defense industry gives us unrivalled experience in antenna radiation and propagation.

**Built to MIL-STD specs.** Engineered to meet demanding military standards MIL-STD-810 and MIL-STD-461. Comrod's Antenna Reduction & Optimization solutions are built to operate efficiently and reliably in the most challenging environments on earth.

**Outstanding SWaP-C.** Antennas and combining systems are compact and lightweight, minimizing deployment weight and maximizing operational efficiency. They integrate seamlessly into vehicles and field shelters.

**Trusted by the best.** Leading defense forces and contractors worldwide rely on our antenna solutions for their mission-critical communications.



# ANTENNA REDUCTION & OPTIMIZATION SYSTEMS

## Mobile and Fixed Platforms

Designed to overcome the demands of limited platform space and co-site interference, our antenna systems approach reduces the antenna footprint while maintaining, or even enhancing overall radiation performance. Embrace the future of military connectivity with our innovative Antenna Reduction and Optimization Systems.

### 4 CHANNELS - 1 ANTENNA

### 4 CHANNELS - 4 ANTENNAS

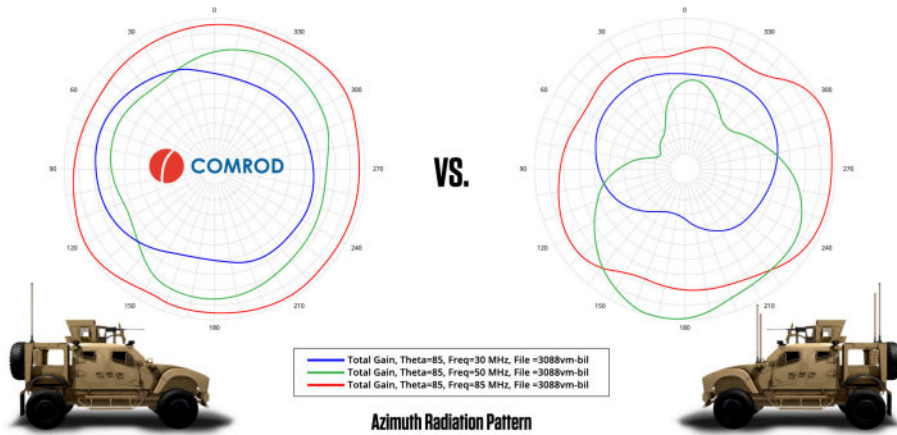

## Featured Product:

### Antenna Control Systems (ACS)

Comrod Antenna Control Systems play a crucial role in enhancing communication reliability and performance. By intelligently combining or splitting signals from multiple antennas, these systems mitigate signal fading, improve diversity, and boost overall system resilience.



ACS016		
Frequencies	Antenna Ports	Radio Ports
VHF	1 x 30-88 MHz	2 x 30-88 MHz
UFO/MUOS SATCOM	1 x 243-380 MHz	3 x 118-480 MHz
UHF	2 x 118-2700 MHz	2 x 243-380 MHz
L-S Band		2 x 700-2700 MHz



# ANTENNA REDUCTION & OPTIMIZATION SYSTEMS

## Field & Ground Deployed

Legacy tactical military antenna farms, pivotal for seamless communication in dynamic battlefield scenarios, face complex challenges in co-site management and radiation pattern performance. Limited space necessitates strategic antenna placement to avoid co-site interference while maintaining optimal radiation pattern performance. Comrod antenna reduction and optimization systems strike a balance between maximizing coverage while minimizing the visual signature. Reduced complexity equates to fewer operators and rapid deployment times.

## Featured Product:

### 7 CHANNELS - 1 COMROD ANTENNA MAST SYSTEM



### 5 CHANNELS - 5 LEGACY ANTENNA SYSTEMS

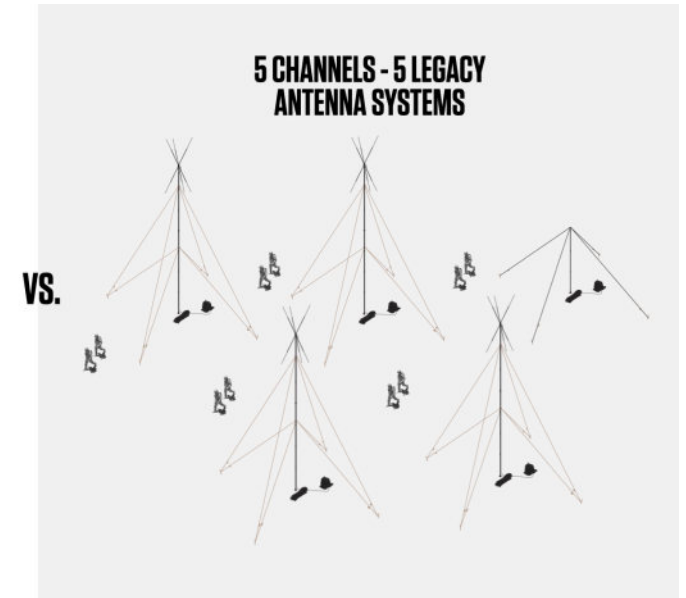

### ETAMS-HF

- Elevated Tri-Band Antenna Mast System (ETAMS) with 4-way VHF splitter
- HF antenna in lower guy position
- Quick deployment time
- Reduced deployment footprint
- Two operators
- Packs into a single bag, small stowage volume
- Optimized antenna system for improved radiation pattern performance
- Supports all new modern waveforms

### Legacy Antenna Farm

- Typical legacy antenna farms consist of 1 x HF antenna and mast system, 4 x VHF antenna and masts systems, 1 x UHF antenna and mast system
- Complex, time consuming deployment
- Large amount of deployment space
- Multiple operators
- Large stowage volume
- Co-site interference due to close proximity of antennas
- Do not support new modern waveforms



# VEHICLE ANTENNAS

Defense customers around the world turn to COMROD for innovative antenna solutions for their vehicle platforms. Solving complex vehicle integration with the latest antenna technology is our strength. MIL-STD-810G ruggedized, single-band and multi-band solutions from 1.6 MHz to 6 GHz.

## Multiband Antenna Evolution

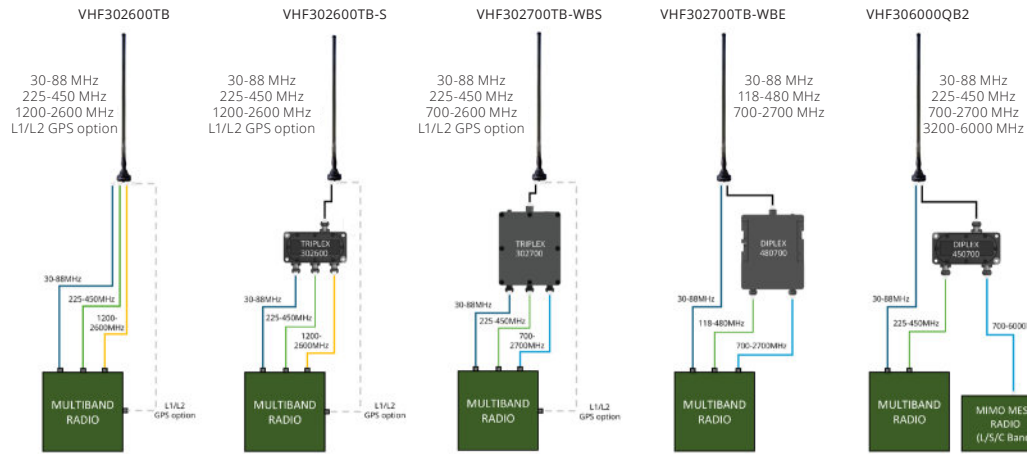

## Featured Products:



### HF Loop (HF230L-OTM):

- HF: 2-30 MHz
- HF communication On-The-Move (OTM)
- Groundwave, NVIS, & Skywave
- Adapts the impedance for high efficiency tuning by the coupler



### UHF MUOS & Legacy SATCOM Antenna (UHF243380S):

- MUOS: 300-320/360-380 MHz
- UFO: 292-318/243-270 MHz
- Quadrifilar Helix
- No groundplane required
- NATO 4-hole flange base
- Radiating element removable from the base





## MANPACK & HANDHELD ANTENNAS

COMROD has been delivering high-performance, rugged manpack and handheld antennas to the world's top defense customers for decades. With antenna solutions covering 1.6 MHz to 6 GHz, Comrod has the right antenna for legacy and modern software defined radios.

### Featured Products:



#### **Dual band UHF / L-S Band Handheld Antenna (UHF2252600DB-HH):**

- Dual-band UHF and L-S Band
- UHF: 225-450 MHz
- L-S Band: 700-2600 MHz
- UHF monopole, L-S Band dipole design
- Small form factor only 30 cm long
- Power rating 5 W CW, 25 W PEP



#### **VHF/UHF Wideband Roll-Up Dipole Antenna (VHF30512UCD):**

- VHF/UHF: 30-512 MHz
- Unique roll-up man-portable design packs down into a single small bag
- Throwing cord for deployment using available structures or trees
- Can be supported with a manpack mast like the 5.4 m Comrod AMX54



#### **Broadband Handheld Dipole Antenna (SHF2060MP)**

- L-S Band 2-6 GHz
- Covers WiFi bands 2.4 GHz and 5 GHz
- Dipole design
- Small form factor only 30 cm long



## GROUND-DEPLOYED ANTENNAS

COMROD has a long history of supplying tactical ground-deployed antenna solutions. Whether you need to elevate, or rapidly ground deploy the antenna at-the-halt, COMROD offers multiple products covering 1.6 MHz to 6 GHz.

### Featured Products:



#### Elevated Tri-band Antenna Mast System(ETAMS):

- Man-portable elevated antenna system with 8.5 m mast
- Antenna frequency range:  
VHF: 30-88 MHz  
UHF: 225-450 MHz  
L-S band: 1200-2600 MHz
- Supports legacy and modern networking waveforms
- Complete kit supplied in one compact bag
- System can be deployed in less than 15 minutes



#### HF Wire Dipole Antenna (HF230XD-BF):

- Comrod HF wire dipole antenna (HF230XD-BF) can replace the ETAMS lower guy position, adding HF dipole coverage in the 2-30 MHz frequency band



#### Band IV Radio Relay (LOS) Dual-Polarized Dish (SHF4459P09):

- Band IV frequency: 4.4 -5.875 GHz
- Dual polarised +/- 90° (H & V)
- Designed for line-of-sight (LOS) and high capacity line-of-sight (HCLOS) radio relay communications
- High gain
- Removable feed for protection and easy transportation







## SHIPBOARD ANTENNA SYSTEMS

COMROD has been producing high quality antennas for the harshest marine environments since the 1960's. Our shipboard antennas can be found on vessels worldwide and have become the trusted source in demanding applications. Today, COMROD continues to introduce cutting-edge antenna technology to the world's naval surface vessel fleets.

### Featured Products:

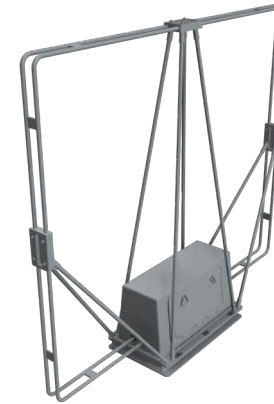

#### **Naval HF NVIS Loop Antenna (HF230L-N):**

- Compact HF antenna for naval platforms
- HF: 1.6-30 MHz
- Continuous communication in Groundwave, NVIS and Skywave
- Superior Near Vertical Incident Skywave (NVIS) performance
- Cost effective, compact installation compared to existing HF naval NVIS solutions
- Power Rating: 500 W PEP



#### **High Power Passive Transformer (AT-T1K):**

- Designed for use with COMROD 10 m side feed whips
- HF: 1.6-30 MHz
- 50 ohm, N type female connector
- 1 KW PEP
- Broadband - no tuning
- Gain comparable to a commercial maritime tuner and whip
- Reduced cabling – no DC power required



## SUBMARINE ANTENNA SYSTEMS

Submarines are subjected to the most demanding and challenging maritime environment. COMROD designs and manufactures antenna systems that meet the challenge of that environment. Our sophisticated submarine antenna solutions deliver high efficiency in small form factors.

### Featured Products:



#### **Fast Tuning HF Antenna System (HF1830S):**

- HF: 1.8-30 MHz
- High power: Up to 1000W PEP
- Fast tuning: 3 ms
- Flexible: Standalone or integration to radio system
- Silent tuning: Tuning without tune power
- State of the art: Designed for 3G-ALE having wide and narrowband modes
- Designed for safety: Compatible with GMDSS MF/HF systems

#### **Multi-Function Wideband Antenna System (MFA303000S-K):**

- Wide coverage: 30-3000 MHz both Tx (selected bands) and Rx
- Highly customizable antenna configuration
- Multi mode: satisfies the need for LoS and Beyond-LoS communication
- Modular: constructed from proven antenna elements that can be exchanged if other needs arise
- Compact: high efficiency in a small form factor, given the number of functions/bands





# MAST OVERVIEW

COMROD is a major supplier of mast solutions for elevating payloads. Telescopic, tripod sectional, and man-portable masts. Regardless of the payload you need to elevate, we have reliable, safe, and efficient solutions.



**TELESCOPIC ALUMINUM  
MASTS**

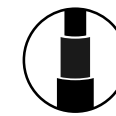

**TELESCOPIC COMPOSITE  
MASTS**



**TRIPOD SECTIONAL  
MASTS**



**MAN-PORTABLE  
SECTIONAL MASTS**



**MAST PAYLOAD  
ALIGNMENT SYSTEMS**



## TELESCOPIC MASTS

Our aluminum TM and composite LMT series of telescopic masts are deployed by hand crank winch, electrical winch or built-in motor drive. MIL-STD-810 qualified and field-proven, our aluminum and composite telescopic masts are designed to stand the test of time. Deployed heights up to 30 m.

### Featured Products:



#### Composite Telescopic Mast Series (LMT Series):

- Fully deployed, un-guyed heights up to 15 m
- Capable of supporting heavy payloads
- Rigid mast for payloads such as EO/IR systems, cameras, sensors, and antennas requiring high pointing accuracy
- Cable management options for routing payload cables inside or outside mast
- Baseplate interface for platform integration

#### Aluminum Telescopic Mast Series (TM Series):

- Heights up to 30 m
- Heavy payload capability on larger masts
- Hand cranked manual winch, electrically driven winch, or built-in motor drive
- Configuration options for nested vs extended heights
- Manufactured from lightweight hexagonal aluminum sections



## TRIPOD SECTIONAL MASTS

COMROD's line of tripod sectional masts are unrivaled for ruggedness, efficiency, and safety. Our Heavy-Duty, Medium-Duty, and Light-Duty masts can reach heights of 34 m. Their composite design make them ultra-light and extremely durable while being capable of lifting payloads up to 130 kg.

### Featured Products:



#### Sectional Tripod Mast (ULM Series):

- Fully deployed heights of 10, 15, 20 & 24 m
- Lightweight carbon composite sleeve masts capable of supporting payloads up to 80 kg
- The tripod support includes a lifting mechanism and hoist to raise each section
- Can be deployed by two operators in 20 minutes or three operators in 15 minutes
- Particularly suited to supporting line-of-site (LOS), directional, omni-directional, or wire antennas, and optronic equipment and sensors



#### Sectional Tripod Mast (MLV Series):

- Fully deployed heights of 10, 15, 20, 30 and 34 m
- Heavy duty composite sectional tripod masts capable of supporting payloads up to 130 kg
- The tripod includes a manual or electric lifting mechanism and hoist to raise each section
- Central guying system enables the guy tension to be maintained by a single operator during deployment of the mast
- 2 or 3 operators can deploy the mast even in high winds
- 360 degree azimuth rotation from the ground to orientate the top load





## MAN-PORTABLE SECTIONAL MASTS

COMROD has a range of man-portable mast solutions to quickly deploy lighter payloads. Made of lightweight composite materials, these masts can easily be deployed by one or two operators in a matter of minutes.

### Featured Products:

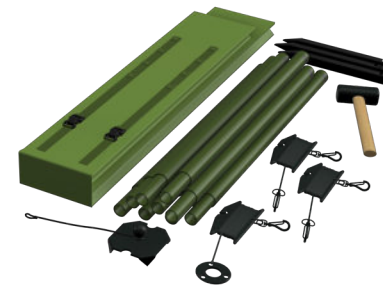

#### Man-Portable Sectional Mast (AMX54):

- Fully deployed height of 5.4 m
- Top payloads up to 3 kg
- 9 lightweight composite sections, 0.6 m (24 in) long
- Single level, three way guy ropes
- Packs down into a single, easy to carry bag
- Quickly and easily deployed by a single person

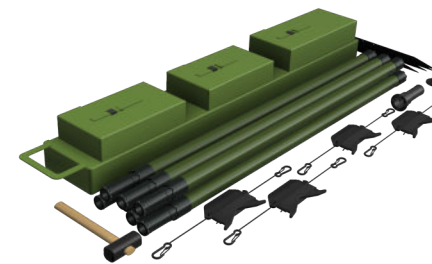

#### Man-Portable Sectional Mast (AMX85):

- Fully deployed heights of 8.5 m
- Top payloads up to 4 kg, or 6 kg with optional lower guy kit
- Quickly and easily deployed by a single operator
- Mast sections fit together to lock azimuth rotation, enabling the use of directional antennas
- Single level, four way guy ropes
- Packs down into a single, easy to carry bag



## MAST PAYLOAD ALIGNMENT SYSTEMS

The COMROD family of CAPAS® Automatic Payload Alignment Systems are designed to meet the challenges faced by today's defense and public safety users. CAPAS® systems enable quick and effective deployment of communication or sensor assets in extreme environments without exposing personnel to unnecessary danger.

### Featured Products:



#### COMROD Automated Payload Alignment System Rotator Tilter (CAPAS-RT2):

- Computer controlled +/- 15° tilt, and 360° rotation of payloads
- Powerful drive system coupled with the integrated magnetic compass ensures fast and accurate positioning
- Supports both closed loop and open loop alignment, or a combination of both
- In closed loop alignment mode, the system is controlled by a radio transceiver to optimize received signal strength and minimize bit error rate
- In open loop mode, the system can utilize input from the COMROD TCT Planning Software for quick initial positioning
- Closed loop feedback from the radio can then further optimize the alignment within a fraction of a degree
- Fully rugged per MIL-STD-810G
- Suitable for deployment on a wide range of COMROD masts including TM, LMT, ULM & MLV series



#### Manual Rotator Tilter:

- Manual (dual rope) controlled +/- 10° tilt, and 360° rotation of payloads
- Precise alignment possible within a fraction of a degree
- Fully rugged per MIL-STD-810G
- Suitable for deployment on a wide range of COMROD masts including TM, LMT, ULM & MLV series





# TACTICAL COMMUNICATION PLANNING

Elevate your communication deployment with Comrod's Tactical Communication Tool. TCT supports public safety and defence applications in addition to deployable emergency telecom infrastructure. Integrating advanced algorithms and an intuitive user interface, our solution takes the guesswork out of tactical communications deployment. Optimize frequency allocation and antenna placement, for optimal signal propagation and enhanced operational effectiveness. With real-time updates and interactive visualization tools, our software ensures adaptability to evolving scenarios. Gain a precise control over radio resources, maximizing communication range and reliability. Whether in military operations, disaster response, or remote expeditions, trust our tactical communication planning tool to deliver unparalleled performance and mission success.

**Deployment Scheduling & Timing.** Maximize deployment efficiency with time-based planning. Strategically allocate resources and tasks with set timeframes, ensuring optimal deployment of assets and timely completion of objectives.

**Inventory Management.** Optimize asset utilization and prevent expensive planning mistakes. Track vehicles, manage equipment, and ensure mission readiness.

**Coverage planning.** Maximize communication reach with our antenna coverage prediction. Ensure reliable connectivity in any environment for enhanced operational efficiency and mission success.

**Link analysis.** Analyse each link in relation to position and terrain for optimised link performance. TCT assesses topography to enhance communication reliability in challenging environments.

**SATCOM planning.** Optimize satellite configurations for frequency and coverage to ensure reliable connectivity for operations.

**Training Tool.** The powerful simulation capabilities makes TCT an excellent classroom tool for training tactical communication, allowing students to explore communication concepts step-by-step and learning how to make the most out of their communication hardware in the field.



**TCT Tactical Communication Planning Software** allows the user to schedule the deployment of tactical communication asset to ensure reliable communications using sophisticated built-in coverage and link analysis tools. TCT has built-in propagation models for multi-vendor tactical communication equipment covering the frequency range 3 MHz to 50 GHz, encompassing a wide range of tactical communication systems such as HF, VHF, UHF, HCLOS, LTE, 5G and Troposcatter.

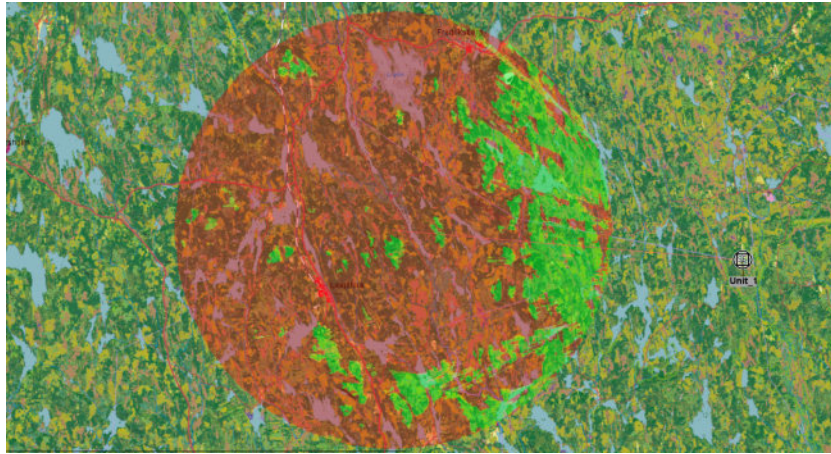

**Deployment Scheduling** enables the operator to sequence when assets are deployed, ensuring synchronisation between the overall mission plan and the communication equipment to support it. Once a plan is created, TCT provides **Inventory and Asset Management** tools to keep track of all the equipment required including antennas, support masts, radios and interconnecting RF cables. An asset requirement list or NATO 5 point order can then be generated for deployment.

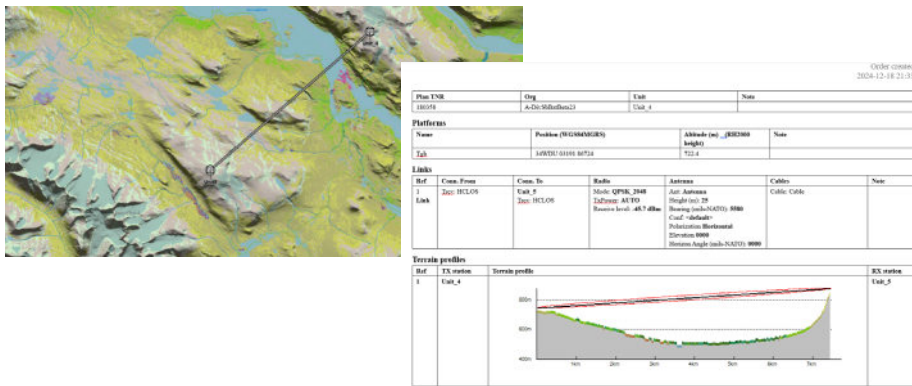

Ref	Conn. From	Conn. To	Radio	Antenna	Cable	Note
1	Spec: HCLOS	Spec: HCLOS	Model: QP16_2148 Height: 48.75m Beam: beam: 48.75m	Ant: Antenna Height: 24 Mount: (incl. NATO) 880 Cof: (inches) Polarisation: Horizontal Diameter: 880 Mount: Angle: (incl. NATO) 880	Cable: Cable	

TCT enables sophisticated **frequency management** and planning to ensure secure, reliable communication in high-stakes environments. Effective planning is crucial for maintaining seamless communication, especially in dynamic or hostile environments. With growing demands on spectrum resources, precise frequency management helps mitigate risks such as signal jamming, interception, or disruption.

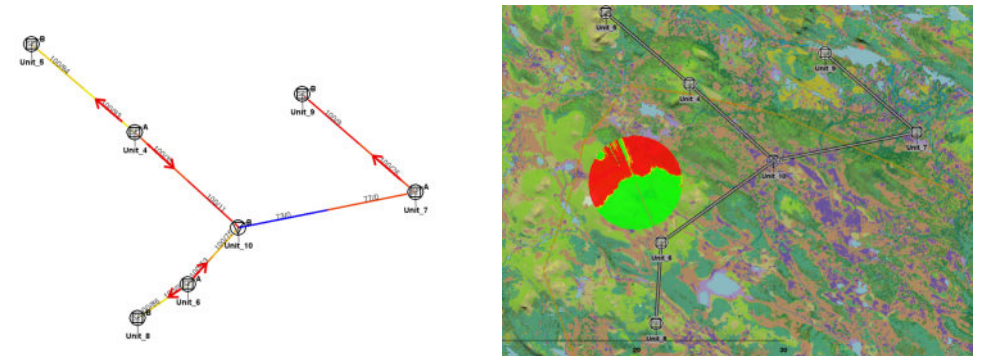

**RF link Analysis** is vital for ensuring robust, reliable communication. TCT includes tools to assess signal strength, coverage, and potential interference across various terrains and operational conditions. By analysing these RF pathways, planners can optimise antenna placement, and ensure sufficient power levels for secure, uninterrupted communication. Our advanced RF link analysis tools ensure dependable, resilient communications, enhancing operational effectiveness.

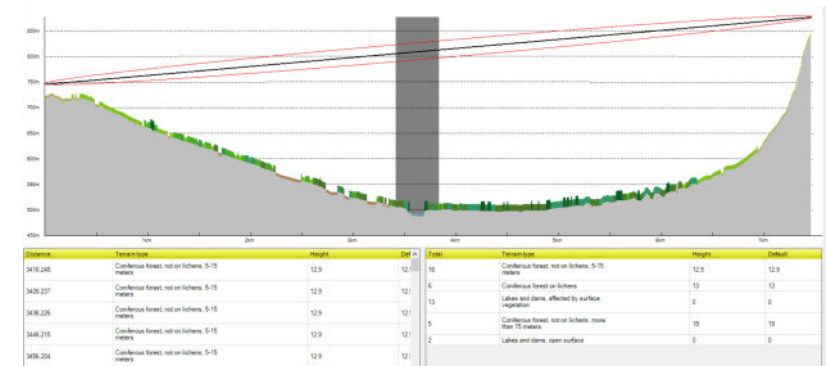

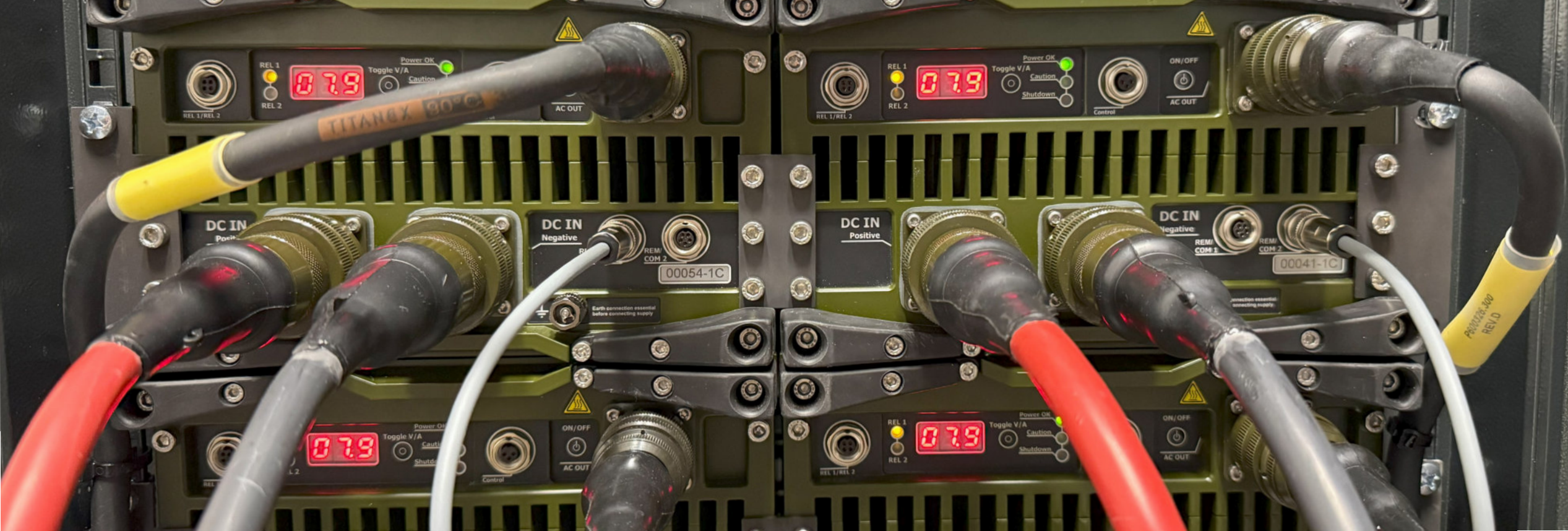

# POWER SUPPLY OVERVIEW

## COMPACT SERIES POWER SUPPLIES & BATTERY CHARGERS

Comrod ComCompact series power supplies are ruggedized, high-performance products engineered for mission-critical operations. Unleash unparalleled power density in a compact form factor, ensuring maximum mobility and reliability. Trust in a power supply that meets the demands of the most challenging environments, delivering consistently when it matters most.

**Built to MIL-STD specs.** Engineered and qualified to demanding standards MIL-STD-810H, MIL-STD-461G, and MIL-STD-1275E. ComCompact series power supplies are shockproof, waterproof and built to operate efficiently and reliably in the most challenging environments on earth.

**Uncompromising performance.** Delivering clean, regulated power, they provide the backbone for communication systems, surveillance equipment, and essential electronics. Choose from AC/DC, DC/DC, and DC/AC options.

**Software Configurable.** Using the Comrod ComCompact Configuration Utility, a full range of configurable parameters enable software customization such as output voltage, current limit, alarm limits, and battery technology.

**Superior Protection.** ComCompact series power supplies are protected from overvoltage, overcurrent, short circuit, reversed polarity and over temperature.

**Outstanding SWaP-C.** ComCompact Series Power Supplies are compact and lightweight, minimizing deployment weight and maximizing operational efficiency. They integrate seamlessly into vehicles and field shelters, mounted in a 19" rack system or operate stand alone.



## Featured Products:

ComPact 2400 AC/DC	
Input	Output
99-276 VAC, 50/60/400 Hz	5-34 VDC, 80 A, 2400 W



Power your mission with our ComPact 2400 AC/DC Power Supply, designed for maximum performance in the harshest conditions. Providing AC to DC conversion with power factor correction, this compact powerhouse ensures a stable and efficient energy source for critical applications. Designed for scalability, it allows multiple units to be connected in parallel to deliver increased power output for power-demanding applications. ComPact 2400 AD/DC is also available with 48 VDC output.

ComPact 1200 12V Dual Input AC/DC & DC/DC		
Input 1	Input 2	Output
99-276 VAC, 50/60/400 Hz	9-16 VDC	5-34 VDC, 40 A, 1200 W



Introducing the unique ComPact 1200 Dual Input AC/DC & DC/DC power supply. Our advanced technology enables seamless switching between AC and DC input power sources, delivering consistent DC output. When AC input is available, it can provide clean 24V to your equipment while simultaneously charging the 12V battery connected to the DC input. Dual Input models are also available with 24 VDC and 36 VDC input.



## Featured Products:

ComPact 2000 DC/AC (Inverter)	
Input	Output
12-34 VDC	100-240 VAC pure sine, 50/60Hz, 2000 W



ComPact 2000 DC/AC inverter transforms DC into reliable pure sine AC. It features advanced Digital Signal Processing (DSP) technology for superior performance and reliability in mission-critical environments. With high surge capabilities, it's designed to handle even the most difficult loads, ensuring consistent operation when you need it most.

ComPact 2000 DC/DC (270 V)	
Input	Output
12-34 VDC	50-350 VDC, 2000 W



Introducing our ComPact 2000 DC/DC which transforms low voltage DC into clean 270 VDC with exceptional efficiency, while maintaining industry-leading EMC performance. Featuring advanced Digital Signal Processing (DSP) technology, it ensures superior precision and reliability in mission-critical environments.



# TRIAD RF OVERVIEW

Triad RF Systems, a COMROD company, is an innovative designer and manufacturer of RF/Microwave amplifiers, RF subsystems, and integrated MIMO radio systems that enable long-range, high-performance datalinks for military and aerospace systems.

Founded in 2013, Triad RF builds on an outstanding track record of providing high-performing products that meet the stringent MIL-STD requirements of military and commercial wireless communications, Satcom and aerospace systems, radar, ISR, unmanned systems, C-UAS, and Electronic Warfare applications.

## PRODUCT GROUPS

- Power Amplifiers
- Bi-Directional Amplifiers
- Up/Down Converters with Integrated Amplifiers
- Radio Frequency Extender Modules
- Integrated Amplified Radio Systems
- Long-range / High-throughput Datalinks

## APPLICATION GROUPS



**RF SIGNAL AMPLIFICATION**



**RADIO RANGE EXTENSION**



**THPR HIGH POWERED INTEGRATED RADIO SYSTEMS**



**C-UAS / EW**



**CUBESAT & SATELLITE SYSTEMS**



**LONG RANGE MIMO DATALINKS**



**TURN-KEY ISR SYSTEMS**



**UNMANNED SYSTEMS DATALINKS**



## RF SIGNAL AMPLIFICATION

Triad's legacy in amplifying long-range, high-data-rate radio links has produced a range of small, lightweight, and rugged Power Amplifiers and Bi-Directional Amplifiers designed to support legacy and next-generation military and aerospace systems. Simple to integrate and built to comply with environmental standards such as MIL-STD810, our amplifiers are the first choice for radio system designs requiring increased RF power for ultra-long-range communication and data links, high data throughput, and other demanding high-power RF applications.

### Featured Products:



#### **L-Band Bi-Directional Amplifier (TTRM1116):**

- Bi-Directional Amplifier
- Amplifies Tx and Rx signals
- L Band: 1200-1400 MHz
- 40 W maximum RF power rating



#### **S-Band Dual Bi-Directional Amplifier (TTRM2005D):**

- Dual channel BDA for 2x2 MIMO radios
- Amplifies Tx and Rx signals
- S Band: 2200-2500 MHz
- 25 W maximum RF power rating
- Highly linear power with low distortion



#### **C-Band Power Amplifier (TA4002R):**

- C Band: 4400-5000 MHz
- 10 W maximum RF power rating
- Highly linear power with low distortion



# THPR HIGH POWER INTEGRATED RADIO SYSTEMS

Elevate your platform's long-range performance with Triad RF's line of fully integrated THPR radio systems.

We take the industry's most popular tactical MIMO / MANET radio systems and improve them with our custom amplifiers, filters, and control/monitoring components, combined into a single SWaP-optimized payload for easy system integration.

Backed by decades of experience in high-power RF engineering and the deployment of long-range, high throughput datalinks, our THPR series radios simplify system integration and deployment of robust wireless links for defense and aerospace systems across all operating domains.

## Featured Products:



- UHF, L, S, or C band MIMO radio system with integrated amplifiers and filtering
- Fully integrated radio systems pair a MIMO radio core with Triad's proprietary amplification technology and other RF subsystems to optimize performance
- Select from the industry's most popular MIMO radio systems, including Domo Tactical Communications, Silvus Technologies, Microhard, and others
- Extended range/data rate over OEM radio systems
- Wide Vin, Single DC Supply
- Enhanced RF Link Control via USB
- Designed to meet MIL-STD-810 and DO-160 standards
- Easy integration into land vehicles, maritime craft, aircraft, and unmanned systems
- 2 or 4 Channel radio configurations available





## CUBESAT & SMALLSAT SYSTEMS

Triad RF Systems offers a range of high-performance, space-rated RF solutions designed to address the challenges of satellite communications. With a flight heritage of over 20 years in Low Earth Orbit (LEO) and more than 550 CubeSat and SmallSat payloads delivered to our customers, Triad provides robust communication systems optimized for the demands of space.

Our CubeSat product lineup includes power amplifiers, bi-directional amplifiers, up/down converters with integrated amplifiers (referred to as "Triad frequency translating amplifiers"), and radio frequency extender modules. Each product is designed to extend range, minimize power consumption, and enhance data throughput.

### Featured Products:



#### Dual Channel, Bi-Directional FDD SSPA (TTRM2020):

- S-Band: 1970-2200 MHz
- Custom RF front end
- Integrated PA, LNA, and dual filter
- Ideal for 5G NB-IoT and NR



#### Power Amplifier (TA1295):

- S-Band: 2000-2500 MHz
- 2.5W of linear power
- Microprocessor controlled power amplification
- Phase Noise, Spurious / Harmonic Performance suitable for LEO RF communication links



#### Frequency Translating Amplifier (TFTA1010):

- Translate Rx / Tx between two radios
- 3.2W PSat Power
- Input: 2125-2625 MHz
- Output: 8000-8500 MHz
- Extend the operational capabilities of existing SDR



## TURN-KEY DATALINK SYSTEMS

For over a decade, Triad RF Systems has specialized in designing and delivering long-range, high-performance data link solutions for manned and unmanned systems, radio range extension, and ISR platforms. Our integrated high-power radio systems and bi-directional amplifiers ensure reliable, long-range, high-data-rate communication links for critical missions.

When in-house or COTS RF solutions fail to deliver the range or product performance required for your mission success, the RF engineering and datalink experts at Triad are ready to help your team succeed.

We offer complete turnkey solutions that optimize RF performance, reduce system complexity, and ensure stable operation even in harsh environments. With decades of experience collaborating with leading UAS and ISR platform providers, Triad delivers custom-tailored solutions, including RF link design and budgeting, system testing, and troubleshooting, to ensure optimal deployed performance for your specific mission requirements. Trust Triad to extend your ISR capabilities and simplify your data link integration.

### Featured Products:

- Antennas: High gain dish and omni-directional antennas, tracking system options
- Masts: Variable-height masts to improve RF propagation and line of sight
- Bi-Directional Amplifiers
- THPR high power MIMO radio systems





**Comrod Communication AS**

Fiskaavegen 1, N-4120, Tau, Norway

[sales@comrod.com](mailto:sales@comrod.com)

[www.comrod.com](http://www.comrod.com)